

Load Curves

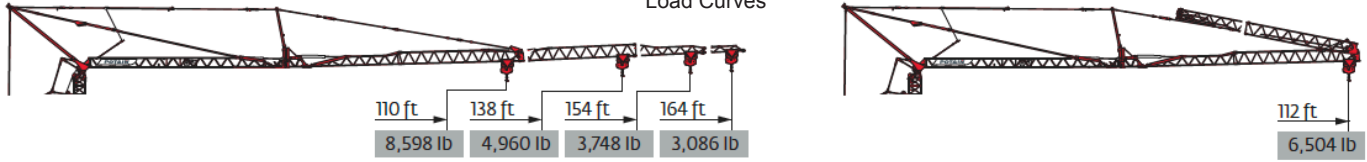

164 ft	11	▶	43	46	52	59	66	72	74	75	79	85	92	98	105	112	118	125	131	138	144	151	157	164	ft		
▲▲▲			17,637	16,314	13,669	11,905	10,362	9,259	-	8,598	8,157	7,496	6,834	6,173	5,732	5,291	4,850	4,519	4,189	3,968	3,748	3,527	3,307	3,086	lb		
											8,818	8,598	8,157	7,496	6,834	6,173	5,732	5,291	4,850	4,519	4,189	3,968	3,748	3,527	3,307	3,086	lb
154 ft	11	▶	46	49	52	59	66	72	79	80	82	85	92	98	105	112	118	125	131	138	144	151	154	ft			
▲▲▲			17,637	16,314	14,991	13,007	11,244	10,141	9,039	-	8,598	8,157	7,496	6,834	6,283	5,732	5,401	4,960	4,630	4,409	4,079	3,858	3,748	lb			
											8,818	8,598	8,157	7,496	6,834	6,283	5,732	5,401	4,960	4,630	4,409	4,079	3,858	3,748	lb		
138 ft	11	▶	50	52	59	66	72	79	82	85	88	89	92	98	105	112	118	125	131	138	ft						
▲▲▲			17,637	16,755	14,330	12,566	11,244	10,141	9,480	9,039	-	8,598	8,378	7,716	7,055	6,504	6,063	5,622	5,291	4,960	lb						
											8,818	8,598	8,378	7,716	7,055	6,504	6,063	5,622	5,291	4,960	lb						
110 ft	11	▶		61	66	72	79	82	85	89	92	98	105	108	110	ft											
▲▲▲				17,637	16,094	14,330	13,007	12,346	11,685	11,244	10,803	9,921	9,039	-	8,598	lb											
											8,818	8,598	lb														

164 ft	11	▶		50	52	59	66	72	79	85	88	92	98	105	112	ft
▲▲▲				17,637	16,755	14,330	12,566	11,244	10,141	9,039	-	8,378	7,716	7,055	6,504	lb
											8,818	8,378	7,716	7,055	6,504	lb

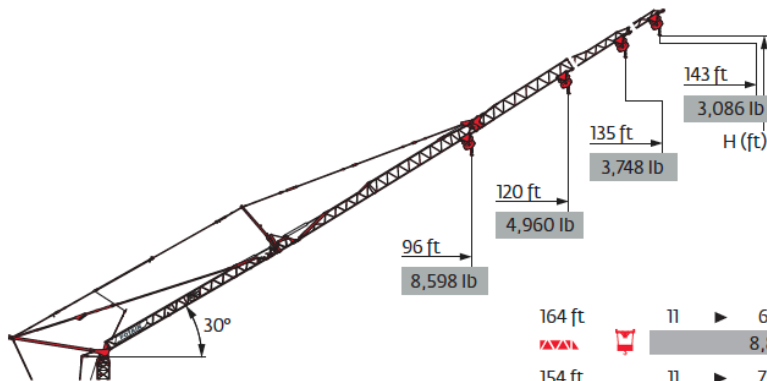





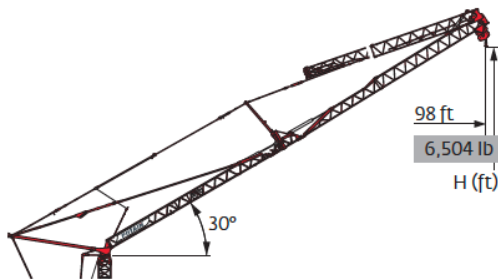

▲▲▲		164 ft	154 ft	138 ft	110 ft
H+3	ⓘ	200	195	-	-
H+2	ⓘ	190	185	-	-
		180	175	166	151
H+1		171	165	156	141
		161	156	147	132
H+0		151	146	137	122





164 ft	11	▶	66	72	79	85	92	98	105	112	118	125	131	138	143	ft
▲▲▲			8,818	7,716	7,055	6,283	5,732	5,181	4,740	4,409	4,079	3,748	3,527	3,307	3,086	lb
154 ft	11	▶	70	72	79	85	92	98	105	112	118	125	135	ft		
▲▲▲			8,818	8,598	7,716	6,834	6,283	5,732	5,291	4,850	4,519	4,189	3,748	lb		
138 ft	11	▶		77	85	92	98	105	112	120	ft					
▲▲▲				8,818	7,716	7,055	6,504	5,952	5,512	4,960	lb					
110 ft	11	▶				94	96	ft								
▲▲▲						8,818	8,598	lb								



164 ft	11	▶		77	79	85	92	98	ft
154 ft				8,818	8,598	7,716	7,055	6,504	lb
138 ft									

▲▲▲	164 ft
▲▲▲	154 ft
▲▲▲	138 ft
H+2	152
H+1	142
	133
H+0	123

480 V - 60 Hz													hp	kW
	33 LVF 20 Optima	fpm	10	52	112	174	207	5	26	56	87	103	29.5	22
		lb	8,818	8,818	8,818	4,409	2,205	17,637	17,637	17,637	8,818	4,409		
	5 DVF 5	fpm	49 - 98 - 128 (4,409 → 17,637 lb) 49 - 98 - 180 (441 → 4,409 lb) 49 - 98 - 230 (0 → 441 lb)									5.4	4	
	RVF 161 Optima+	rpm	0 → 0.8									7.5	5.5	
	TVF 124	fpm	82									2 x 4	2 x 3	

 IEC 60204-32	 kVA
480 V (+6% -10%) 60 Hz	 31 → 19 kVA  35 → 22 kVA 

33 LVF 20 Optima

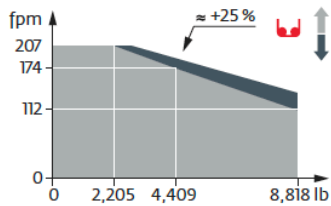

Erection

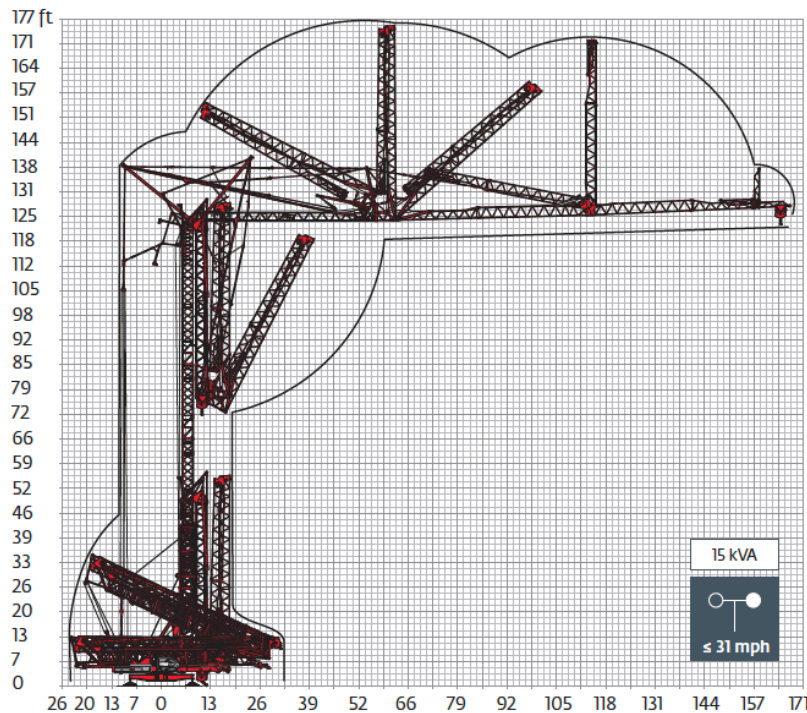

Transport

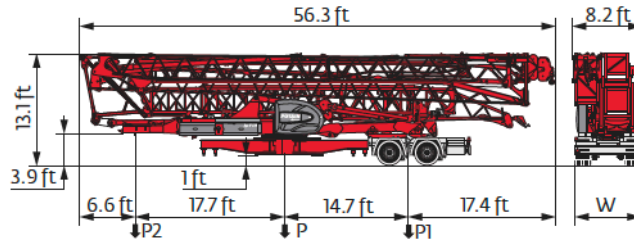

Erection

	mph	W (ft)	P (lb)	P1 (lb)	P2 (lb)
SL121/S215M	15.5	7.9	66,359	42,549	23,810

NORTH AMERICAN HIGHWAY AXLE

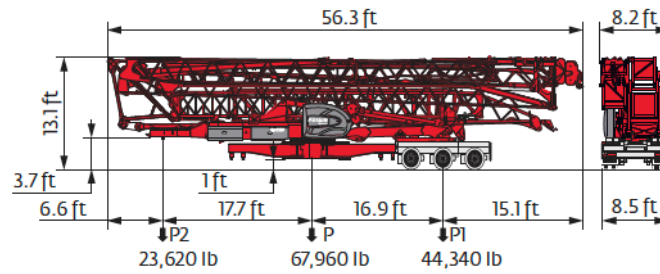

- R Rear slewing radius
- i Consult us
- Reactions in service
- Reactions out of service
- ▲ Weight without load, without ballast, without transport axles, with max. jib and standard height
- ▲ Total ballast weight
- Standard equipment
- Options
- + Hoisting
- Trolleying
- Slewing
- Travelling
- kVA Required power
- Ⓢ Power Control Function: winch speeds adapted to the available power

Hook heights given with plated pulley block

 This commercial document is not legally binding

For any technical information, please refer to the corresponding instructions